

# UNIT SIZE CALCULATION

TOLERANCE:  $\pm \frac{1}{8}$ "

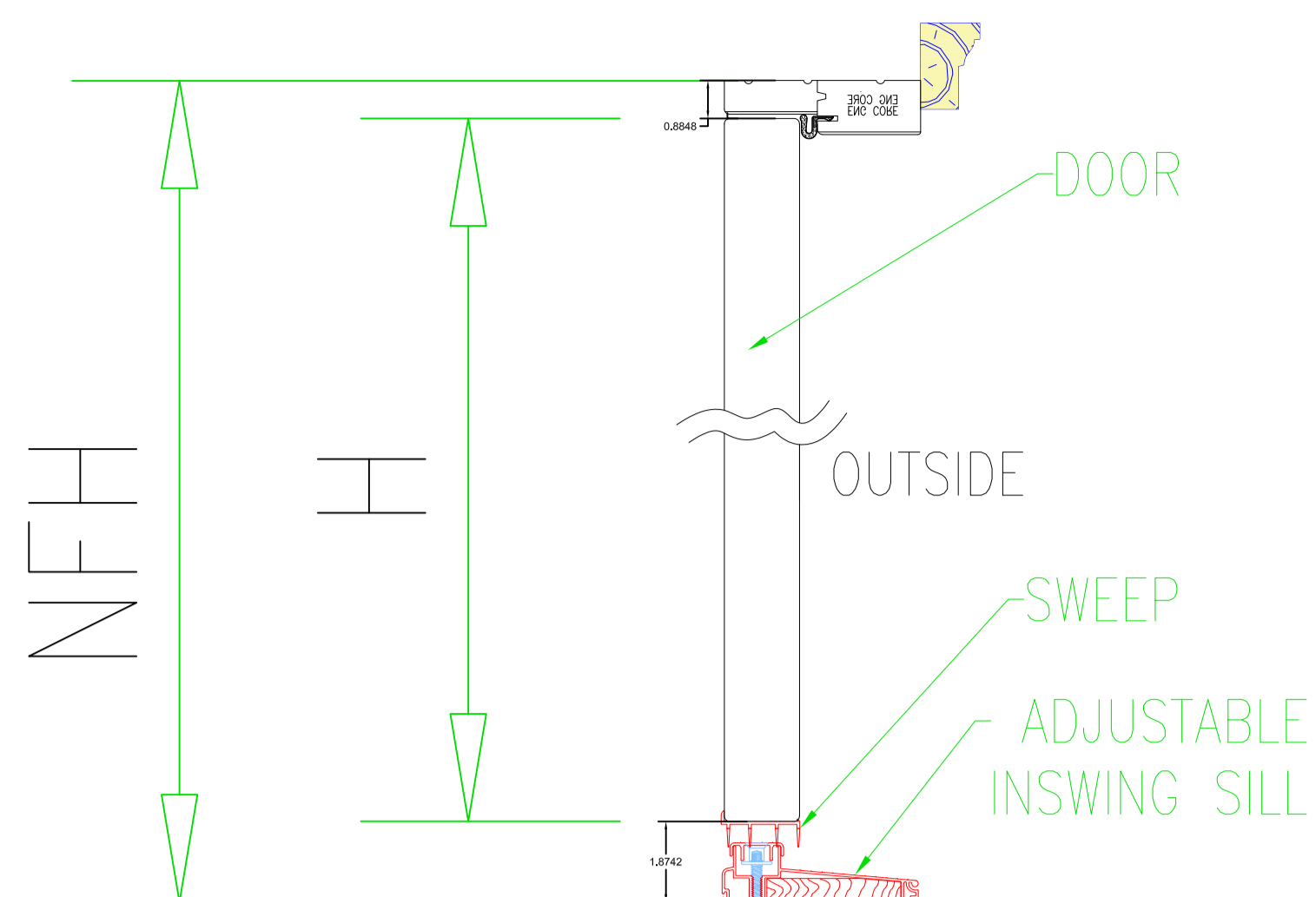

US Door & More Inc.  
4904 SAVARESE CIR  
TAMPA, FL 33634



Inswing NFH:  $H + 2 \frac{3}{4}$ "

- W: Door Width
- SW: Sidelite Width
- H: Door Height
- NFH: Net Frame Height
- NFW: Net Frame Width

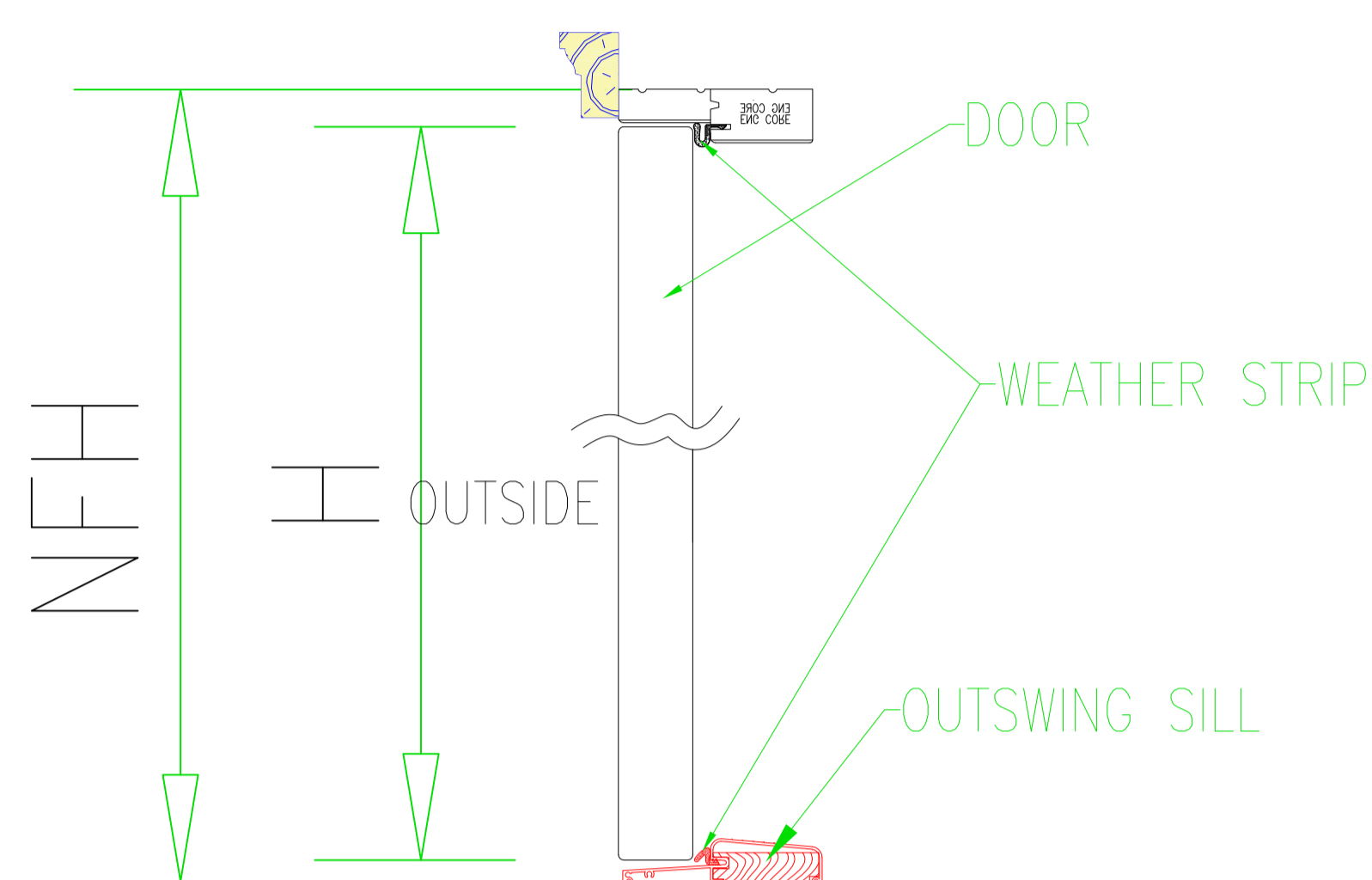

Outswing NFH:  $H + 1 - \frac{3}{8}$ "

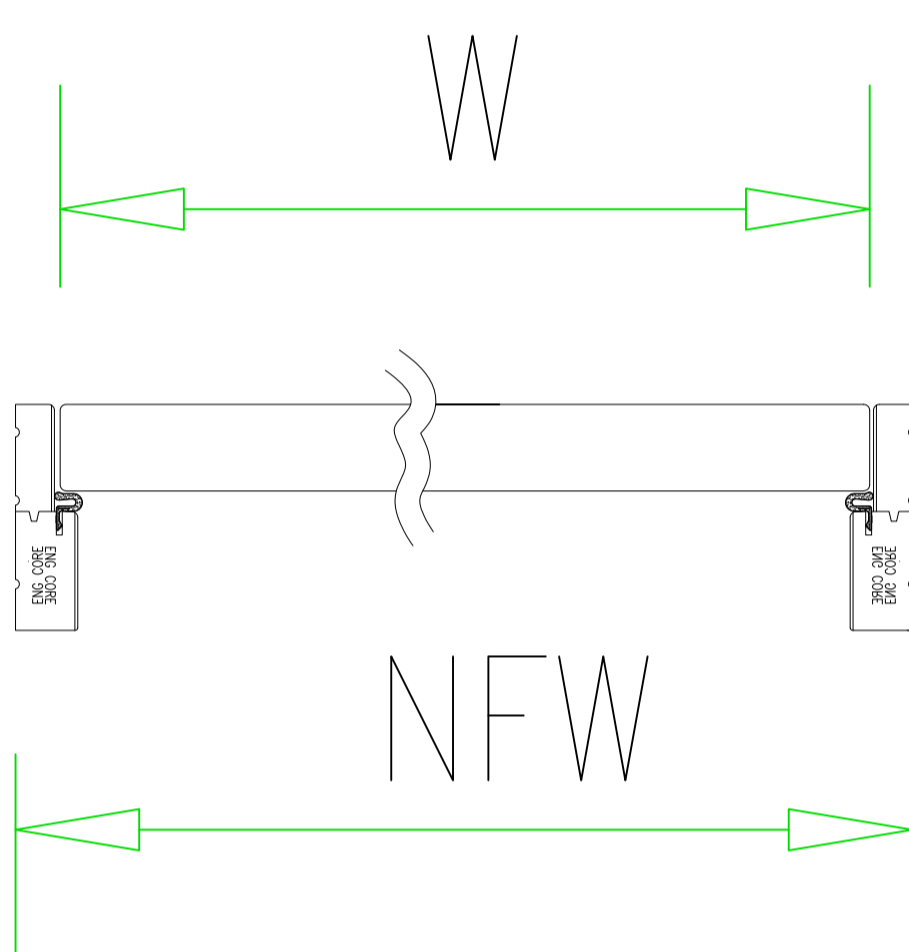
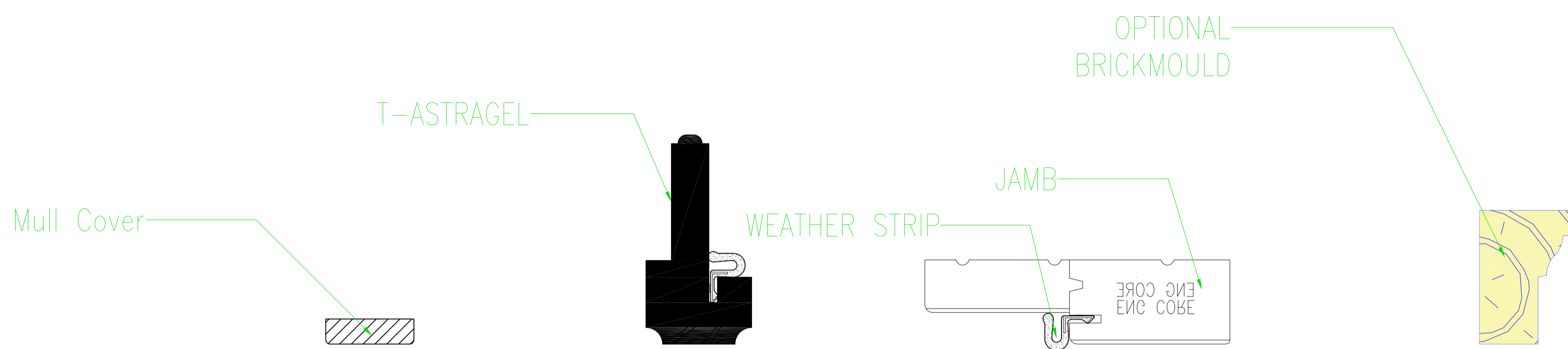

NFW:  $W + 1 \frac{3}{4}$ "

Single Door

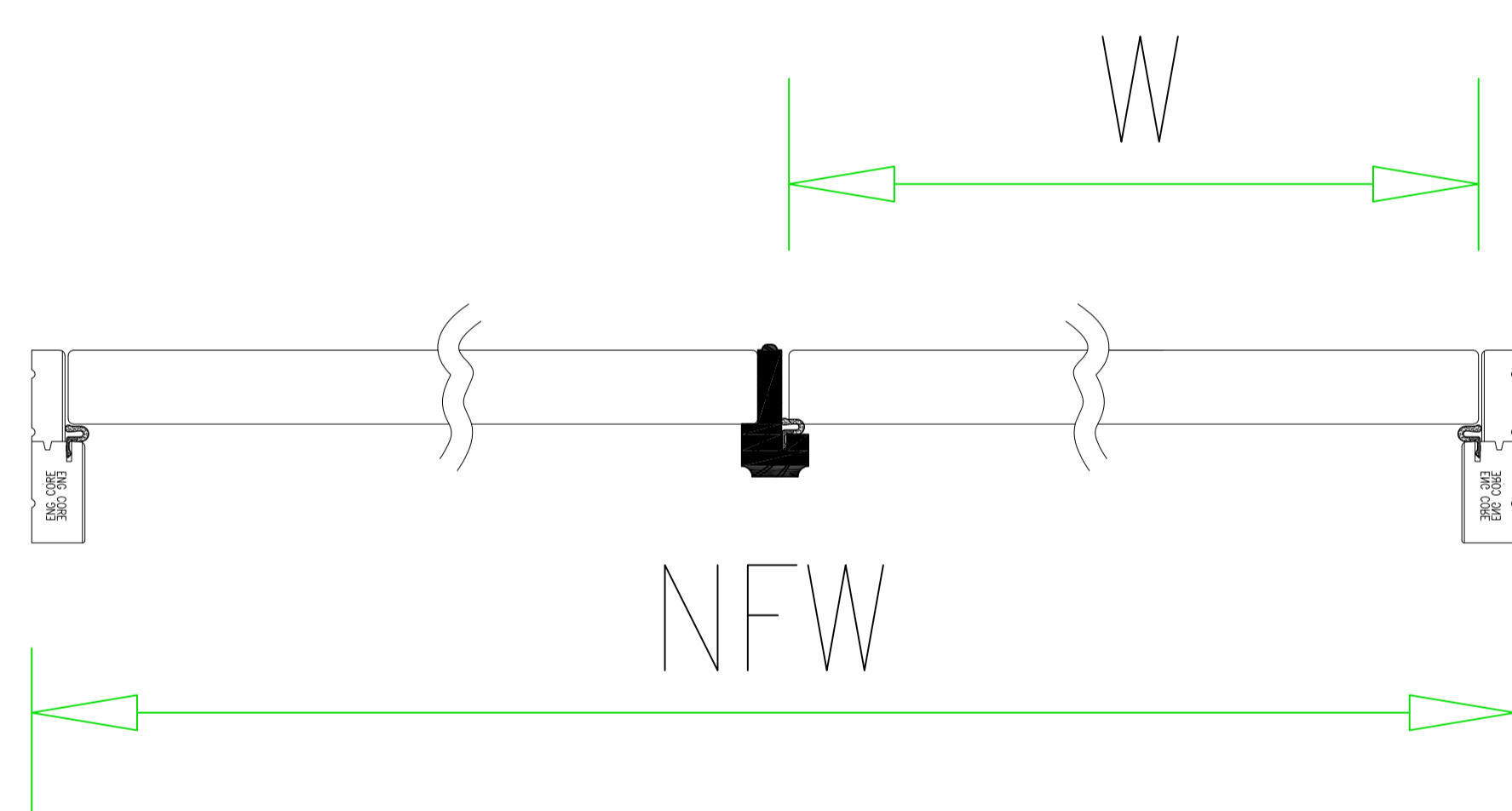

NFW:  $(2 \times W) + 2 \frac{1}{2}$ "

Double Door

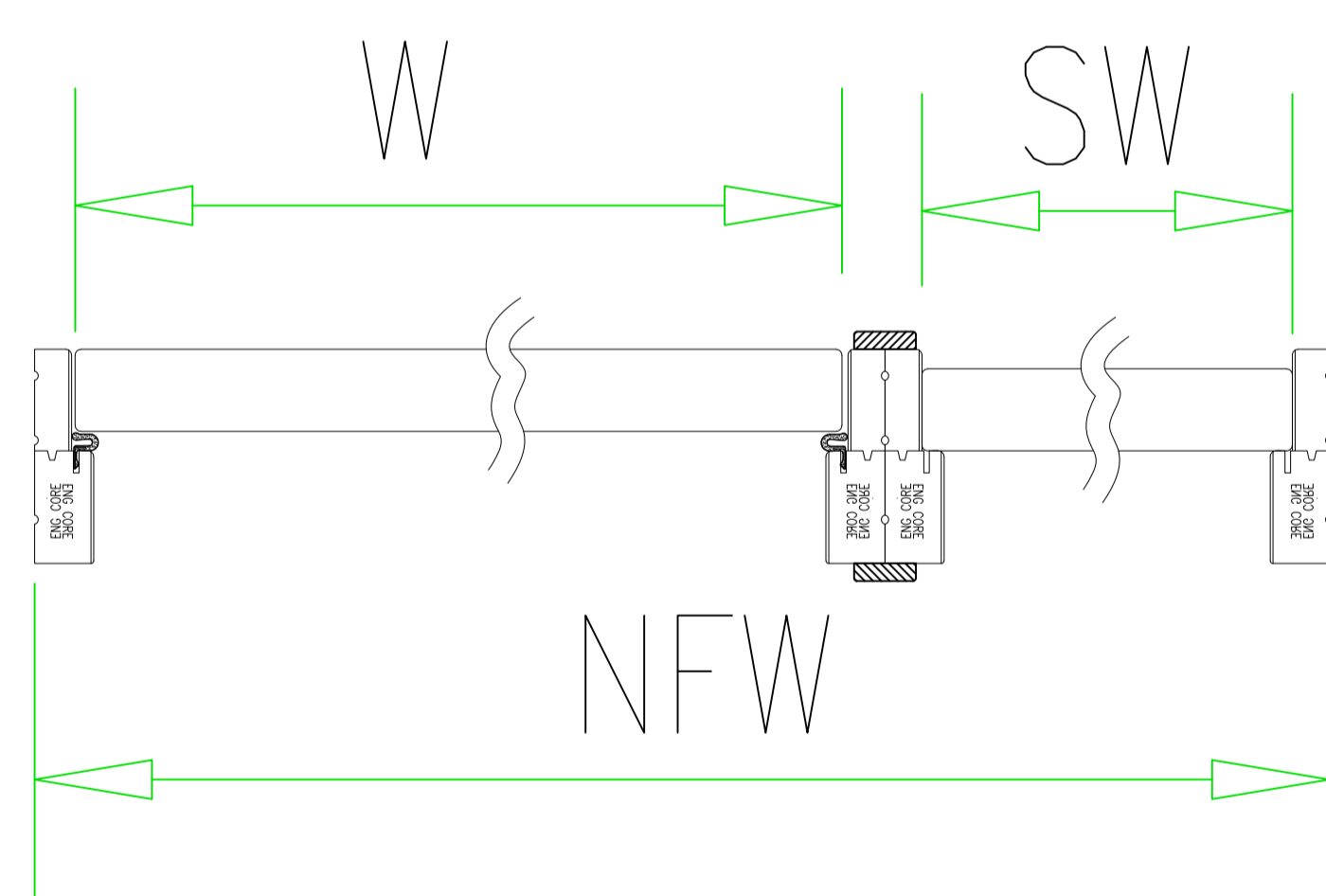

NFW:  $SW + W + 3 \frac{15}{16}$ "

Single Door & One Sidelites

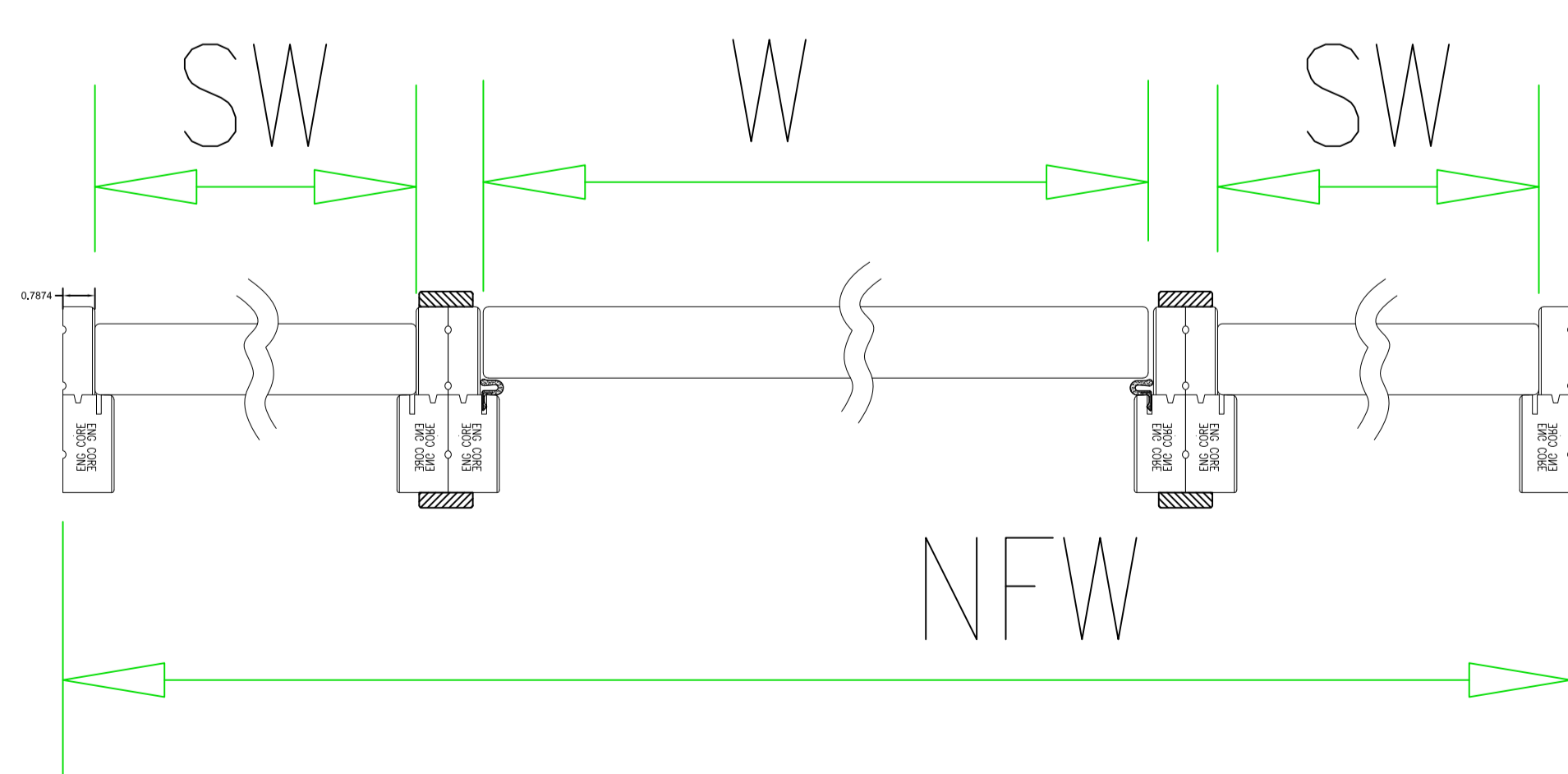

NFW:  $(2 \times SW) + W + 5$ "

Single Door & Two Sidelites

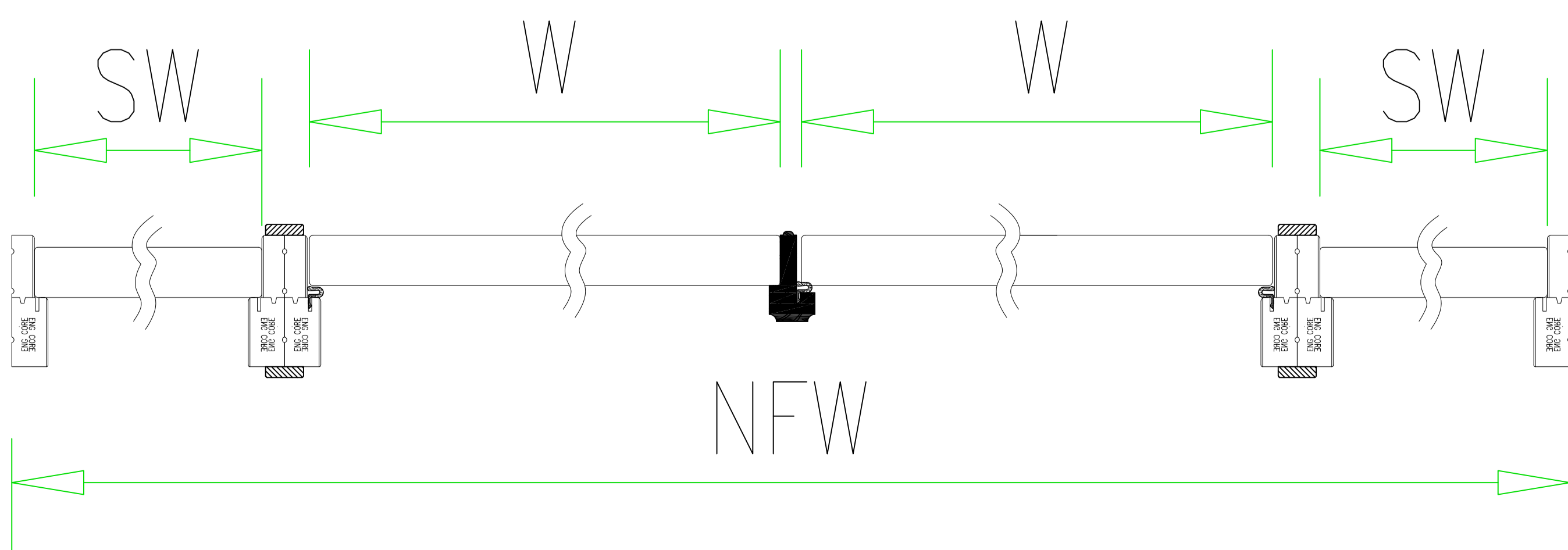

NFW:  $(2 \times SW) + (2 \times W) + 5 \frac{7}{8}$ "

Double Door & Two Sidelites